

WHEEL AND TYRE

WHEEL AND TYRE

CONTENTS

GENERAL INFORMATION	2	ON-VEHICLE SERVICE	4
SERVICE SPECIFICATIONS	2	Tyre Inflation Pressure Check	4
TROUBLESHOOTING	3	Tyre Wear Check	4
		Wheel Runout Check	4
		WHEEL AND TYRE	4



GENERAL INFORMATION

The wheels and tyres of the following specifications have been established.

SPECIFICATIONS

Items		Specification
Wheel	Type	Steel Aluminium*
	Size	16 × 6JJ
	Amount of wheel offset mm	46
	Pitch circle diameter (P.C.D.) mm	114.3
Tyre	Size	215/65R16 98S



NOTE

*: Optional items

SERVICE SPECIFICATIONS

Items		Limit
Tread depth of tyre mm		1.6
Wheel runout (Radial runout) mm	Steel wheel	1.2 or less
	Aluminium wheel	1.0 or less
Wheel runout (Lateral runout) mm	Steel wheel	1.2 or less
	Aluminium wheel	1.0 or less

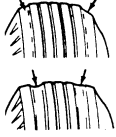
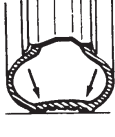
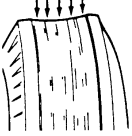
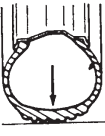
TROUBLESHOOTING

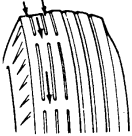
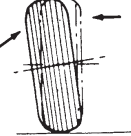
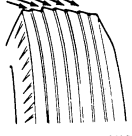
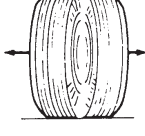
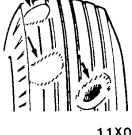
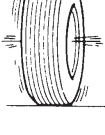
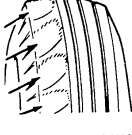
Symptom		Probable cause		Remedy	Reference page
Rapid wear at shoulders	 11X0109	Under-inflation or lack of rotation	 11X0116	Adjust the tyre pressure.	31-4.
Rapid wear at centre	 11X0110	Over-inflation or lack of rotation	 11X0117		
Cracked treads	 11X0111	Under-inflation		Adjust the tyre pressure.	31-4.
Wear on one side	 11X0112	Excessive camber	 11X0118	Inspect the camber.	Refer to GROUP 33A – On-vehicle Service.
Feathered edge	 11X0113	Incorrect toe-in	 11X0119	Adjust the toe-in.	
Bald spots	 11X0114	Unbalanced wheel	 11X0120	Adjust the imbalanced wheels.	–
Scalloped wear	 11X0115	Lack of rotation of tyres or worn or out-of-alignment suspension		Rotate the tyres and check the front suspension alignment.	Refer to GROUP 33A – On-vehicle Service.

ON-VEHICLE SERVICE

TYRE INFLATION PRESSURE CHECK

NOTE

For information on tyre inflation pressure, refer to the label attached near the driver's side door striker.

TYRE WEAR CHECK

Measure the tread depth of tyres.

Limit: 1.6 mm

If the remaining tread depth is less than the limit, replace the tyre.

NOTE

When the tread depth of tyres is reduced to 1.6 mm or less, wear indicators will appear.

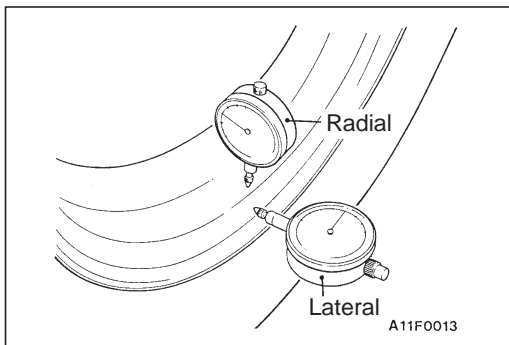

WHEEL RUNOUT CHECK

Jack up the vehicle so that the wheels are clear of the floor. While slowly turning the wheel, measure wheel runout with a dial indicator.

Limit:

Item	Steel wheel	Aluminium wheel
Radial runout mm	1.2	1.0
Lateral runout mm	1.2	1.0

If wheel runout exceeds the limit, replace the wheel.

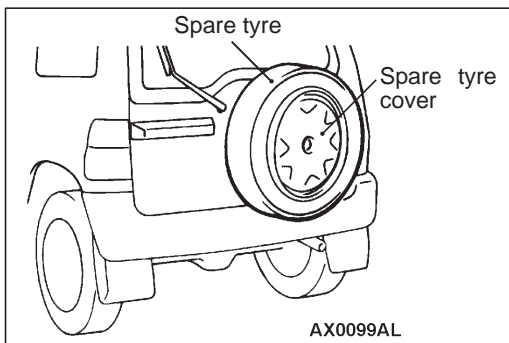

WHEEL AND TYRE

INSTALLATION SERVICE POINT

Tighten the wheel nut to the specified torque.

Tightening torque: 98 Nm

When installing the spare tyre and spare tyre cover to the spare tyre carrier, tighten the wheel nut, lock cylinder and bolt to the specified torque.

Tightening torque: 46 Nm

GROUP 31

WHEEL AND TYRE

GENERAL

OUTLINE OF CHANGE

A newly designed aluminium wheel has been added. Its appearance has been improved by attaching a balance weight on the rim inside surface.

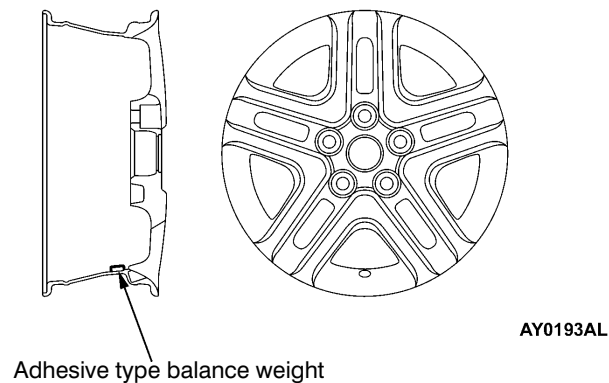

GENERAL INFORMATION

SPECIFICATIONS

Items		Specification
Wheel	Type	Aluminium type*
	Size	16 × 6J
	Amount of wheel offset mm	46
	Pitch circle diameter (P.C.D.) mm	114.3

NOTE

*: Optional items