

SUPERWINCH®



OWNER'S MANUAL

INSTALLATION • OPERATION • MAINTENANCE
SAFETY PRECAUTIONS • REPAIR PARTS

HUSKY 10
12 and 24 Volt DC Electric Winch
Part No. 2404 and 2405

▲ CAUTION

**READ AND UNDERSTAND THIS MANUAL
BEFORE INSTALLATION AND OPERATION
OF YOUR SUPERWINCH PRODUCT.**

Superwinch, Inc. Superwinch, Ltd.
Winch Drive Abbey Rise, Whitchurch Road
Putnam, CT 06260 Tavistock, Devon PL 19 9DR
U.S.A. England
Tel. (860) 928-7787 Tel. +44 (0) 1822 614101
Fax (860) 928-1143 Fax +44 (0) 1822 615204

94-10035 Rev E 2/8/00

SUPERWINCH GARANTIE LIMITÉE

VALABLE A TRAVERS LE MONDE
GARANTIE LIMITÉE. Superwinch, Inc. (le "Vendeur") garantit à l'acheteur d'origine ("vous") que toutes les pièces et composants, à l'exception du câble métallique, sont sans vice de matériaux ou de fabrication, et ce, pendant une période d'un (1) an à compter de la date d'achat prouvable. Tout produit Superwinch défectueux sera réparé ou remplacé sans dépenses de votre part, si vous respectez ces procédures. Les garanties énoncées par les présentes sont exclusives tiennent lieu de toutes autres garanties expressées ou implicites.

PROCEDURE DE RECOURS A LA GARANTIE LIMITÉE.
Des découverts d'un produit Superwinch défectueux, vous devez envoyer à Superwinch, à l'usine ou à un Centre de réparation autorisé par l'usine, une notification écrite dudit défaut et vous devrez envoyer par courrier ou autre service de livraison le Superwinch défectueux, port et frais postaux payés à l'avance. Les réparations ou remplacements par le Vendeur conformément à la présente Garantie s'effectueront normalement dans les quinze (15) jours ouvrables suivant réception du Superwinch défectueux. Le Vendeur ou ses Agents autorisés peut facturer des frais raisonnables pour les pièces et la main d'œuvre en cas de réparation non couverte par la présente Garantie limitée.

LIMITATIONS ET EXCLUSIONS EN CE QUI CONCERNE LA GARANTIE ET LES REMÈDES.
La réparation et/ou le remplacement de tout Superwinch défectueux ou de tout composant d'un tel Superwinch tel que convenu par les présentes est votre remède exclusif. Les exclusions et limitations de garanties et les limitations de REMÈDES ci-dessous seront expressément applicables :

A. Garanties expressées. Le Vendeur garantit que le Superwinch est tel qu'il est décrit dans le "Mode d'emploi Superwinch" fourni avec la présente; aucune autre garantie expresse n'est donnée en ce qui concerne le Superwinch. Si un modèle ou échantillon vous a été montré, lectid modèle ou échantillon a été utilisé à des fins d'illustration uniquement et ne sera pas considéré une garantie que le Superwinch sera conforme au modèle ou à l'échantillon. **LE VENDEUR NE DONNE AUCUNE GARANTIE EXPRESSE EN CE QUI CONCERNE LE CÂBLE MÉTALLIQUE INCORPORÉ AU PRODUIT.**

B. Garantie implicite. **LA GARANTIE IMPLICITE DE L'APTITUDE À LA VENTE ET TOUTE AUTRE GARANTIE IMPLICITE S'APPLIQUERA UNIQUEMENT POUR UNE DURÉE D'UN (1) AN À COMPTER DE LA DATE D'ACHAT PROUVABLE. LE CÂBLE MÉTALLIQUE EST VENDU "TEL QUEL" SANS AUTRE GARANTIE IMPLICITE. CERTAINS ÉTATS AMÉRICAINS NE PERMETTENT PAS DE LIMITER LA DURÉE DES GARANTIES IMPLICITES; IL EST DONC POSSIBLE QUE LA LIMITATION CI-DESSUS NE S'APPLIQUE PAS À VOTRE CAS.**

C. Domages indirects. **SUJET AUX OBLIGATIONS DE LA GARANTIE LIMITÉE DU VENDEUR ÉNONCÉES DANS LE PRÉSENT DOCUMENT, LE VENDEUR NE SERA AUCUNEMENT RESPONSABLE DE DOMMAGES INDIRECTS, DE QUELQUE NATURE QUE CE SOIT, NI DE DOMMAGES INDIRECTS À LA PROPRIÉTÉ, NI DE PERTES DE PROFITS, NI DE PERTES D'UTILISATION POUVANT SURVENIR À CAUSE D'UN DÉFAUT, D'UN MAUVAIS FONCTIONNEMENT OU D'UNE PANNE QUELCONQUE DU SUPERWINCH CH-JOINT. CERTAINS ÉTATS AMÉRICAINS NE PERMETTENT PAS D'EXCLURE OU DE LIMITER LES DOMMAGES INDIRECTS; IL EST DONC POSSIBLE QUE LA LIMITATION CI-DESSUS NE S'APPLIQUE PAS À VOTRE CAS.**

D. Condition de la garantie. Le Vendeur ne sera pas tenu de se conformer aux obligations de garantie fournies par les présentes si la cause du défaut, du mauvais fonctionnement ou de la panne du Superwinch est un dommage (ne résultant pas de composants défectueux ou qui fonctionnent mal) ou une utilisation déraisonnable par vous. Le terme "utilisation déraisonnable" prend mais ne est pas limité au manquement à la maintenance, à l'installation et à l'utilisation raisonnables et nécessaires conformément aux consignes contenues dans le Mode d'emploi Superwinch, et à l'utilisation du Superwinch pour des charges supérieures à celle figurant dans le Mode d'emploi pour le modèle en question. La responsabilité du Vendeur sous la présente garantie ou pour toute perte du produit Superwinch ou dommage à celui-ci ne dépassera pas le coût de correction des défauts du produit Superwinch ou de remplacement de celui-ci, et lors de l'expiration de la période de garantie, toute telle responsabilité prendra fin. Les agents, distributeurs et employés du Vendeur ne sont pas autorisés à modifier la présente garantie ni à donner d'autres garanties complémentaires obligatoires pour le Vendeur. Toute déclaration supplémentaire, qu'elle soit écrite ou orale, ne constituera donc pas une garantie et ne devra pas être considérée comme valable.

REMÈDES LEGAUX DE L'ACHETEUR. Cette garantie limitée vous donne des droits légaux spécifiques et il est possible que vous ayez d'autres droits qui varient d'un état à l'autre aux États-Unis et d'un pays à l'autre. Vous avez également des droits de garantie implicite. En cas de problème avec le service ou la performance suivant la garantie limitée, il est possible que vous puissiez intentionner une action en justice devant la Cour des Prudhommes ("small claims court"), devant le tribunal d'état ou devant le tribunal fédéral des États-Unis ou dans une autre juridiction appropriée en dehors des États-Unis.

QUESTIONS. Toute question en ce qui concerne le respect des garanties énoncées dans les présentes doit être envoyée, par écrit, à : Superwinch, Inc., Winch Drive, Putnam, CT 08260 U.S.A. ou à Superwinch Limited, Abbey Rise, Whitchurch Road, Tavistock, Devon PL 19 9DR, England

UNPACKING

This carton contains the following items. Please unpack carefully. **Read instructions before beginning.**

Description	Quantity
Winch assembly with wire rope and hawse	1
M10 x 50mm mounting bolts	4
M10 lock washers	4
5/16 x 3/4 long ground screw	1
5/16 lock washer	1
Owner's manual	1
Hand saver	1
Remote control	1
Cable ties	5
Lead wire assembly 62" black (winch to battery ground)	1
Allen wrench kit with 6mm, 4mm and 1/4" wrenches	1
21mm long spacers	4

INTRODUCTION

Thank you for buying a Husky 10 from Superwinch. It has been designed and manufactured to provide years of trouble-free operation. We hope you will be pleased with its performance. If you are not, for any reason, please contact our Customer Service Department: (866) 928-7787 USA; +44 (0) 1822 614101 England.

When requesting information or ordering replacement parts; always give the following information:

1. Winch Part Number (2404/8548)
2. Serial Number (found on drum support casting)
3. Part Number (found in Replacement Parts List section)
4. Part Description

Please read and understand this Owner's Manual prior to installing and using your winch. Pay particular attention to the General Safety Information. Your winch is a very powerful machine. If used unsafely or improperly, there is a possibility that property damage or personal injury can result. We have included several features in this winch to minimize this possibility; however, your safety ultimately depends on your caution when using this product.

⚠ CAUTION Pay particular attention to the caution notes preceded with the symbol shown here. The notes contain advice for your protection.

Correct installation of your winch is a requirement for proper operation. If you intend to install your winch on the front end of your vehicle **use the mounting (fitting) kit** which has been designed and manufactured by Superwinch to accommodate your winch and fit your vehicle.

Note the electrical requirements of the Husky 10 winch you have purchased: Part Number 2404, 12 Volt DC system ONLY. Part Number 2405, 24 Volt DC system ONLY. Congratulations on your choice!

FEATURES

Electric Motor – 1.9 peak hp (1.4 kw) of power available.

Primary Gear Reduction – Case hardened nickel steel spur gears in heat treated aluminum housing and grease lubricated for life.

Final Gear Reduction – Steel centered phosphor bronze wormwheel driven by case hardened ground and polished nickel steel worm running in substantial ball and roller bearings mounted in a heat treated

aluminum housing. Oil lubricated for guaranteed long life.

Braking – The action of the worm and wormgear provides for substantial braking action – no brake pads to wear or delicate mechanisms to break.

Drum – Fabricated steel running in copolymer maintenance free bearings with spring loaded brakes to prevent overrun when pulling out the wire rope.

FEATURES (CONT.)

Drum Clutch – Operated by an easy action lever (painted red) which disengages the drum to allow the wire rope to be pulled out without using electric power. The drum clutch is multi-splined for low contact pressure.

Control Solenoids (relays) – Boxed pair solenoids can be mounted directly on winch or remotely as required.

Remote Control – 12 ft. hand held remote control assembly with an interlocking reverse switch and trigger is engineered to the same standards as the winch.

Mounting – Attaching position allows for platform or chassis mounting in under wind mode only.

PERFORMANCE *

Wire Rope Layer	Max. Pulling Capacity lbs	kg
1	10,000	4536
2	8,175	3708
3	6,925	3141
4	6,000	2722
5	5,295	2402

SPECIFICATIONS

Working Load* . . .10,000 lbs. (4535 kg)
 Stall Load11,500 lbs. (5216 kg)
 Wire Rope3/8" x 90"
 Voltage12 Volt DC

*Based on first layer performance.

GENERAL SAFETY INFORMATION

Your HUSKY 10 winch is a very powerful machine. Treat it with respect, use it with caution and always follow these safety guidelines.

▲WARNING *The wire rope may break before the winch stalls. For heavy loads, use a pulley block to reduce the load on the wire rope.*

1. THE HUSKY 10 winch is rated at 10,000 pounds capacity. **DO NOT OVERLOAD. DO NOT ATTEMPT PROLONGED PULLS AT HEAVY LOADS.** DO NOT MAINTAIN POWER TO THE WINCH IF THE MOTOR STALLS. Overloads can damage the winch and/or the wire rope and create unsafe operating conditions. FOR HEAVY LOADS, WE RECOMMEND THE USE OF THE OPTIONAL PULLEY BLOCK AND HOOK ASSEMBLY (PART NO. 7750A) TO DOUBLE LINE THE WIRE ROPE (FIG. 2). This reduces the load on the winch and the strain on the wire rope by approximately 50%. If attaching back to vehicle, attach to the frame or other load bearing part. The vehicle engine should be running during winch operation to minimize battery drain and maximize winch power and speed. If considerable winching is performed with the engine off, the battery may be too weak to restart the engine.

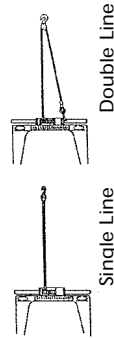

Figure 2

2. AFTER READING AND UNDERSTANDING THIS MANUAL, LEARN TO USE YOUR WINCH. After installing the winch, practice using it so you will be familiar with it when the need arises. Periodically check the winch installation to assure that all bolts are tight.

3. DO NOT "move" your vehicle to assist the winch in pulling a load. The combination of the winch and vehicle pulling together could overload the wire rope and the winch itself.

4. KEEP CLEAR OF THE WINCH, WIRE ROPE, AND THE WINCHING OPERATION ITSELF. KEEP PEOPLE OUT OF THE WINCHING AREA. OPERATE THE WINCH WITH A CLEAR, UNOBSTRUCTED VIEW OF THE WINCHING OPERATION. ALWAYS BE AWARE OF POTENTIAL HAZARDS, ASK YOURSELF WHAT WILL HAPPEN IF THE WIRE ROPE TACKLE OR SOMETHING BREAKS?

5. INSPECT WIRE ROPE AND EQUIPMENT FREQUENTLY. A FRAYED WIRE ROPE WITH BROKEN STRANDS SHOULD BE REPLACED IMMEDIATELY. Always replace wire rope with the manufacturer's identical replacement part (see Replacement Parts List). Any substitution must be IDENTICAL in strength, quality, lay and stranding. OTHER EQUIPMENT used with the winch such as tackle, hooks, pulley block, straps, etc. should be inspected for damage that could reduce their breaking strength.

GENERAL SAFETY INFORMATION (CONT.)

6. **USE HEAVY LEATHER GLOVES** when handling wire rope. **DO NOT LET WIRE ROPE SLIDE THROUGH YOUR HANDS.** A broken strand could seriously injure your hands.

7. **NEVER WINCH WITH LESS THAN 5 TURNS OF WIRE ROPE AROUND THE DRUM** since the wire rope end fastener will NOT withstand a load.

CAUTION

8. **KEEP CLEAR OF WINCH WIRE ROPE AND HOOK WHEN OPERATING WINCH.** NEVER put your fingers through the hook when reeling in or out the last few feet of rope near the hook. If your finger should become trapped in the hook, you could lose your finger. Use the **HANDBSAVER BAR** (Figure 3) to guide the hook within the last few feet. Never guide a wire rope onto or off the drum with your hand.

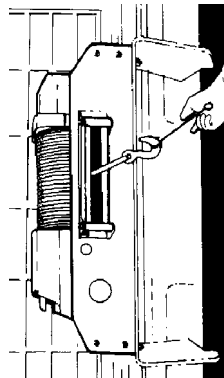

Figure 3

9. **NEVER HOOK THE WIRE ROPE BACK ONTO ITSELF.** Use a nylon sling (Superwinch Part Nos. 2531 or 1509). Hooking the wire rope onto itself can damage the rope (Figure 4).



Figure 4

10. It is a good idea to lay a heavy blanket or jacket over the wire rope near the hook end when pulling heavy loads (Figure 5). If a wire rope failure should occur, the cloth will act as a damper and help prevent the rope from whipping. Raise the hood of the vehicle for added safety.

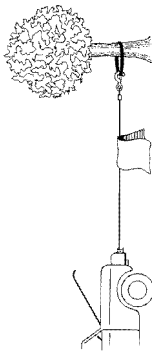

Figure 5

11. **NEVER USE YOUR WINCH FOR LIFTING PEOPLE OR MOVING PEOPLE OR ANYTHING CONTAINING PEOPLE. The winch is not designed nor intended for use in lifting or moving people.**

12. Your winch is not designed or intended for overhead hoisting operations.

13. **AVOID CONTINUOUS PULLS FROM EXTREME ANGLES** as this will cause the wire rope to pile up at one end of the drum (Figure 6). This can jam the wire rope in the winch, causing damage to the wire rope or winch itself.

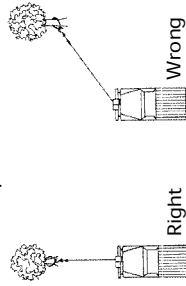

Figure 6

GENERAL SAFETY INFORMATION (CONT.)

14. **NEVER INSTALL WINCH IN SUCH A WAY THAT THE WARNING AND INSTRUCTION LABELS ARE OBSCURED.** Someone who has not read this manual may need to see them to understand the proper operation of the winch.

15. Always operate winch with an unobstructed view of the winching operation.

16. IT IS RECOMMENDED THAT A FAIRLEAD BE USED to guide the wire rope onto the winch. Operator injury or winch damage can result if a fairlead is not installed.

17. **NEVER RELEASE CLUTCH WHEN THERE IS A LOAD ON THE WINCH.**

18. **STORE THE REMOTE SWITCH ASSEMBLY IN A SAFE PLACE** when not in use to prevent use by children or other unauthorized persons who could injure themselves or others.

19. **DO NOT OPERATE WINCH WHEN UNDER THE INFLUENCE OF DRUGS, ALCOHOL OR MEDICATION.**

20. **ALWAYS UNPLUG THE REMOTE SWITCH BEFORE WORKING IN OR AROUND THE FAIRLEAD OR WINCH DRUM (THE DANGER ZONE)** so that the winch cannot be turned on accidentally.

21. **NEVER WORK ON OR AROUND THE FAIRLEAD OR WINCH DRUM WHEN WINCH IS UNDER LOAD.**

22. When using your winch to move a load, place the vehicle transmission in neutral, set vehicle parking brake, chock all wheels, and keep the engine running.

23. **DO NOT USE THE WINCH TO HOLD LOADS IN PLACE.** Use other means of securing loads such as tie down straps.

Superwinch offers a wide variety of tie downs. Contact your local Superwinch dealer.

24. **USE ONLY FACTORY APPROVED SWITCHES, REMOTE CONTROLS AND ACCESSORIES.** Use of non-factory approved components may cause injury or property damage and could void your warranty.

25. **DO NOT MACHINE OR WELD ANY PART OF THE WINCH.** Such alterations may weaken the structural integrity of the winch and could void your warranty.

26. **DO NOT WINCH IN THE OVERWIND POSITION.**

27. Your Husky 10 winch wire rope has a ten-foot red "safety stripe" on each end. The "safety stripe" at the end of the wire rope that attaches to the drum warns you that the wire rope is almost completely payed out.

DO NOT use the winch for this last ten feet of wire rope since the wire rope end fastener will NOT support a heavy load. The "safety stripe" at the hook end of the wire rope warns you that the wire rope is almost rewound. **ALWAYS USE THE HANDBSAVER BAR** when handling the hook (Figure 3). As you use your winch, the red paint will wear off due to normal wear. When this happens, you should renew the red paint as it is a safety feature of the winch.

- 28. Use caution when moving a load on a ramp or incline. Stay clear of, and keep people, pets, and property out of the path of the load.
- 29. WHEN MOVING A LOAD SLOWLY, TAKE UP THE WIRE ROPE SLACK UNTIL IT BECOMES TAUT. STOP, RECHECK ALL WINCHING CONNECTIONS. BE SURE ALL TACKLE IS PROPERLY SEATED. CHECK THE WIRE ROPE TO BE SURE IT IS RUNNING PROPERLY IN ANY PULLEYS.

INSTALLATION

MOUNTING YOUR WINCH

Because your winch has a vented oil filled gear box, it must be mounted upright to prevent the oil from draining out.

Superwinch mounting (fitting) kits are available for most popular vehicles. If you can't locate a kit locally, contact Superwinch at the address listed on the front of this manual for the name of a Superwinch dealer near you. Detailed mounting instructions are provided with each mounting kit. Read and install carefully to ensure proper winch alignment and trouble-free operation. Improper mounting could damage the winch and void warranty.

TOOLS REQUIRED

- Open End Wrenches (Spanners): (2) 9/16", (2) 1/2", (2) 7/16", (2) 3/8"
- Torque Wrench: 75 lb. ft. range with 1/2" drive
- Ratchet Wrench with 1/2" drive: 3/4" Socket, 17mm Socket
- Phillips Screw Driver

ELECTRICAL INSTALLATION
The Husky winch operates on either 12 or 24 volts direct current, not both.
DO NOT CONNECT WINCH TO EITHER 110 VOLT HOUSE CURRENT OR 220V MAINS AS WINCH BURNOUT OR FATAL SHOCK MAY OCCUR!

For trouble-free winch operation, be sure the battery is always fully charged and maintained. The performance of an electric winch is directly dependent on the quality and capacity of the battery and alternator.

Note: For best operation, BCI Group 27 battery and a 55 amp alternator are the minimum recommended power sources. Winch performance will be lessened by decreasing these capacities.

When the winch is in use, the engine of the vehicle should be run at fast idle to supplement battery reserve power. If the winch is in heavy use, an auxiliary battery and heavy duty alternator with a battery isolator (Superwinch Part No. 2216) are recommended.

ELECTRICAL LEAD WIRE ATTACHMENT

CAUTION
Automobile batteries contain gases which are flammable and explosive. Wear eye protection during installation and remove all metal jewelry.

Do not lean over battery while making connections.

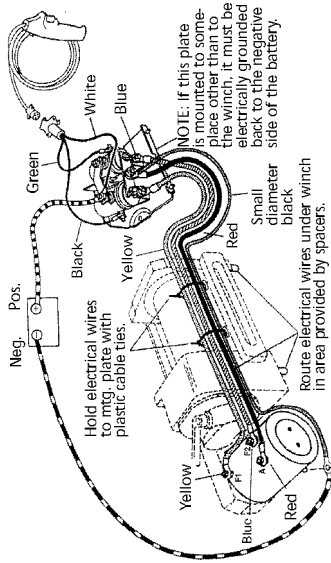

Figure 9

1. Disconnect the vehicle battery.
2. Remove the motor cover. Check motor terminals against wiring diagram for identification
3. Attach lead wire assemblies as shown in wiring diagram. Attach lead wire to battery negative terminal last to prevent shorts or sparks.

CAUTION
When attaching wire to the motor terminals and solenoids (relays), hold the inner nut when tightening the outer nut. Do not allow the motor terminals to rotate causing internal wire breakage. Be especially careful in preventing the solenoid (relay) terminals from rotating. Any rotation can damage the solenoid (see Figure 10).

Your color coded wire leads and small diameter (10GA) black wire lead should be routed under the winch and strapped to the mounting plate with the cable ties provided. The non-color coded wires should be routed through the vehicle grill to the battery. Use the 6ga. (smaller diameter) wire for the ground wire. To ensure against insulation abrasion and/or cutting, apply several layers of electrical tape where wiring may come in contact with sharp metal parts of the vehicle.

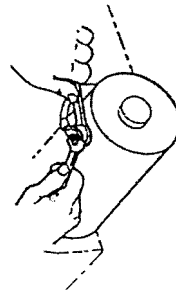

Figure 10

CAUTION Double check your wiring. Incorrect wiring could result in motor burnout or personal injury!

4. Replace and secure motor cover.
5. Reconnect the battery positive, then the negative (earth) terminal. Switch the clutch lever to the "Disengage" position. Pull several feet of wire rope off the drum. Switch the clutch lever back to the "Engage" position. Plug in the hand control to "Rope-Out" position. Pull trigger momentarily to check wire rope drum rotation direction. If drum rotates in the wrong direction, reverse the green and black wires that connect the remote control receptacle to the small solenoid terminals.

CAUTION To prevent unauthorized use of winch, remove switch assembly and store in a clean, dry area such as the glove box.

PULLING OUT THE WIRE ROPE

Move the Clutch Lever to the "Disengage" Position as shown in Figure 11. Pull out the wire rope and secure to anchor or load. Check that there are at least 5 turns left on the Drum. Re-engage the Drum by moving the Clutch Lever to the "Engage" Position (Figure 11). If it does not slide easily into engagement, it may be necessary to pull out a small amount of wire rope to position the drum with the clutch.

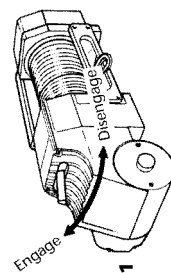

Figure 11

OPERATION
SWITCH OPERATION

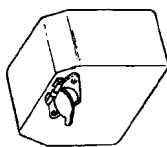

Figure 12

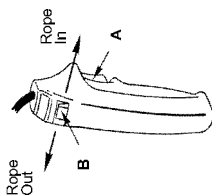

Figure 13

The hand-held switch activates the solenoids located in the control box. The solenoids control the forward and reverse operations of the winch motor.

To connect the switch, lift the spring loaded cover on the plug receptacle (see Figure 12). The plug on the switch cord is keyed to fit into the socket only one way.

The trigger on the switch returns to the "off" position when released (Fig. 13, Item A). The slide button on the back of the switch determines the direction of drum rotation for "Rope In" or "Rope Out" operations (Figure 12, Item B). The slide is fitted with an interlock so that the motor cannot be reversed if the trigger is depressed. To change direction, release the trigger, move the slide button, and depress the trigger again.

CAUTION The switch assembly must be kept free of dirt and moisture to ensure safe operation.

TIPS FOR EXTENDING THE LIFE OF YOUR WINCH

1. BREAK-IN. Winch life and performance will be greatly enhanced by progressive break-in. We recommend 1,000 to 1,200 feet of pulling, the first 350 feet pulling a vehicle without the brakes applied and during the remainder the brakes can be applied progressively harder.

Note:

- A. Installing the wire rope is not included in the "break-in" period.
- B. Check tightness of all mounting bolts after "break-in."

2. KEEP A TIGHTLY WOUND WIRE ROPE DRUM. Do not allow the wire rope to become loosely wound. A loosely-wound drum allows a wire rope under load to work its way down into the layers of wire rope on the drum. When this happens, the wire rope may become wedged within the body of the windings, damaging the wire rope. To prevent this problem, keep the wire rope tightly and evenly wound on the drum at all times. During winching, periodically check to see that the wire rope is winding on evenly. A good practice is to rewind the wire rope under tension after each use. One way to do this is to attach the hook to a stationary object at the top of a small hill or incline and winch your vehicle up the incline.

3. DO NOT ALLOW MOTOR TO OVERHEAT. Remember, the winch is only for intermittent use. During long or heavy pulls the

motor will get hot. The internal parts will be hotter than the case. To check the motor temperature, stop winching and carefully touch the end of the motor. If the end of the motor is uncomfortably warm, allow the motor to cool before continuing. Keep the engine running to recharge the battery during this break.

4. USE A PULLEY BLOCK FOR HEAVY LOADS. To maximize winch and wire rope life, use a pulley block (Part No. 7750A) to double line heavier loads.



5. The pull required to start a load moving is often much greater than the pull required to keep it moving. Avoid frequent stopping and starting during a pull.
6. PREVENT KINKS BEFORE THEY OCCUR.

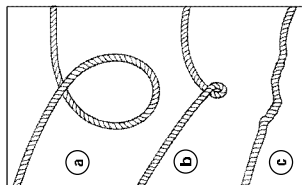

- a. This is the start of a kink. Wire rope should be straightened.
- b. The wire rope was pulled and loop has tightened into a kink. Wire rope is now permanently damaged and must be replaced.
- c. The result of kinking is that each strand pulls a different amount causing strands under greatest tension to break and reduce load capacity. The wire rope must be replaced.

7. Equipping the winch with a roller fairlead (Part No. 2539) will substantially reduce wear on the wire rope during angle pulls. The rollers eliminate heavy rubbing and abrasion to the wire rope.

MAINTENANCE

After the first 10 hours of operation: Change Worm Gearbox oil (see Figure 14 for location of drain hole and level plug). Check tightness of mounting bolts and electrical connections.

Monthly: Check tightness of all electrical connections and remove any dirt or corrosion that may have accumulated. Check oil level in worm gearbox. Oil level should be maintained to the lower edge of the plug hole with the winch in the upright position as shown in Figure 14.

After 50 hours of winching or annually: Change Worm Gearbox oil.

LUBRICATION

The spur and worm gear boxes are self contained and individually lubricated. The spur gearbox is factory filled for life with BP Energearse FGL which is suitable for the majority of climates. In extreme climates, contact Superwinch for advice.

Climate	Temperature	Spur Gearbox	Worm Gearbox
Arctic	5° to 59° F	BP to Energearse FGL*	SAE 90 oil
Temperate	32° to 86° F	BP to Energearse FGL*	SAE 85/140 oil
Tropical	68° to 122° F	BP to Energearse FGL*	SAE 140 oil

*Available from Superwinch

REPLACEMENT PARTS LIST

Reference Number	Description	Part Number	Qty
1	Wormbox Assembly (includes 2,3,7)	85-90170	1
2	Oil Seal	4-22-5572103	1
3	Plug	4-29-224	2
4	Wormset	85-95019	1
5	Needle/Roller Thrust Bearing	7721	1
6	Needle Bearing	4-12-25322013	1
7	Thrust Bearing	4-07-2542203	1
8	Thrust Washer	4-03-2542203	2
9	Location Plug	7667	1
10	Oil Seal	4-22-2535073	1
11	O-Ring	4-21-6543	1
12	Bearing Carrier	7654	1
13	Spring Pin	4-56-401003	1
14	Clutch Member	7659	1
15	Retaining Ring	4-24-4053183	1
16	O-Ring	4-21-7813	1
17	Clutch Assembly (includes 18, 19, 20, 21, 22, 23)	85-90174	1
18	Clutch Shaft	7676	1
19	Operating Lever	7673	1
20	O-Ring	4-22-6423	1
21	Spring Pin	4-56-602603	1
22	Ball	4-54-79324	1
23	Spring	4-31-7629510223	1
24	Support Housing (includes 25)	85-90138	1
25	Flanged Bearing	7653	2
26	Rope Drum Assembly 3" (includes 27)	9108	1
27	Socket Set Screw	4-40-081003	1
28	Gear Housing	85-90394	1
29	Cover	7649	1
30	Gasket	7689	1
31	Gear Motor 27T (2404)	7663	1
32	Gear Motor 32T (2405)	85-54008	1
33	Gear Intermediate 64/20T (2404)	85-90172	1
34	Gear Intermediate 59/20T (2405)	85-90171	1
35	Gear, Wormshaft 46T	7666	1
36	Retaining Ring	4-24-19227103	1
37	Retaining Ring	4-26-1618123	1
38	Spacer	7686	1
39	Key	7764	1
40	Ball Bearing	94-23079-05	1
41	Brake Shoe	317	1
42	Brake Spring	320	1
43	Motor Cover	7683	1
44	Gasket	7689	1
45	M8 Lock Washer	4-51-0823	1
46	Screw M5 x 50	7691	1
47	Motor 12 Volt (2404)	7682-I	1
48	Motor 24 Volt (2405)	7694-I	1

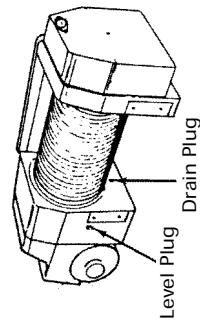

Figure 14

Note: EP (Extreme Pressure) additives can damage copper based alloys like phosphor bronze used for the worm gear and we do not recommend their use in the worm gear box. If any doubt exists, consult your lubricant supplier's technical department. The drum bearings and splined drum clutch are lubricated with polydisulphide loaded bearing grease.

REPLACING THE WIRE ROPE

Never substitute a heavier or lighter wire rope. Never use rope made of any material other than wire.

Always replace damaged wire rope with the manufacturer's identical replacement part (see Replacement Parts list). Any substitution must be IDENTICAL in strength, quality, lay and stranding. Pass attaching end of wire rope through the hawse and attach into the drum.

It is important that the wire rope be wound tightly on the drum. A good way to do this is to attach the wire rope hook to a fixed object at the top of a slight incline, then winch the vehicle up the incline.

REPLACEMENT PARTS LIST

Reference Number	Description	Part Number	Qty
46	Shim	4-01-8090073	AR
47	Shim	4-01-8090123	AR
48	M6 x 25 Socket Head Cap Screw	4-36-0602522	16
49	M6 Lock Washer	4-51-0623	16
50	M8 x 20 Socket Head Cap Screw	4-36-0802022	8
51	M8 Lockwasher	4-51-0823	6
52	5/16-24 UNF Nut	180	3
53	Hawse Fairlead (includes 50,51)	2504	1
54	Base Plate Assembly	85-90148	1
55	#10 x 3/4 Sheet Metal Screw	94-23160-08	1
56	Bracket Solenoid	94-20118	1
57	Flange Nut	94-23149-01	2
58	12V Solenoid (2404)	92-20172	2
	24V Solenoid (2405)	92-20193	2
59	#1 Buss Bar	92-20126	2
60	#10-32 Flange Nut	92-23149-01	2
61	#10-32 x 1/2 Machine Screw	92-23125-01	2
62	M8 x 16 Hex Head Cap Screw	4-32-0801622	2
63	Front Buss Bar Assembly	92-12385	1
64	5/16 Lock Washer	92-23057-03	1
65	5/16-18 Hex Nut	92-23034-04	1
66	Top Buss Bar	92-12383	1
67	#8-32 Flange Nut	90-20149-06	2
68	Control Box Cover	7709	1
69	Socket Half Connector Assembly	90-22115	1
70	#8-32 x 5/8 Machine Screw	90-23032-03	2
71	#2 GA 76" Lead Wire Ass'y (2404)	92-20187-04	1
	#6 GA 62" Lead Wire Ass'y Red (2405)	94-23292-04	1
72	#2 GA x 30" Lead Wire Ass'y Yellow (2404)	94-20187-27	1
	#6 GA x 30" Lead Wire Ass'y Yellow (2405)	94-23292-32	1
73	#2 GA x 30" Lead Wire Ass'y Red (2404)	94-20187-26	1
	#6 GA x 30" Lead Wire Ass'y Red (2405)	94-23292-33	1
74	#2 GA x 30" Lead Wire Ass'y Blue (2404)	90-20187-32	1
	#6 GA x 30" Lead Wire Ass'y Blue (2405)	94-23292-31	1
75	#6 GA 62" Lead Wire Ass'y	92-20187-05	1
76	#10 GA 30" Lead Wire Ass'y	94-20187-33	1
77	Remote Control Ass'y	90-22117	1
78	3/8 x 90 ft. Wire Rope Ass'y	2537	1
79	Hook Assembly	94-20116	1
80	Hand Saver	89-32300	1
81	Solenoid Pack Pre-Wired (2404)	94-23373-01	1
	Solenoid Pack Pre-Wired (2405)	94-23373-02	1
NS	Roller Fairlead	2539	1
NS	Tie Strap	7713	1
NS	BP Energrease FGL (Enough for one relube)	94-23284-01	1
NS	M8 x 20 Hex Head Cap Screw	4-33-0802022	2

NS Denotes Not Shown AR Denotes As Required

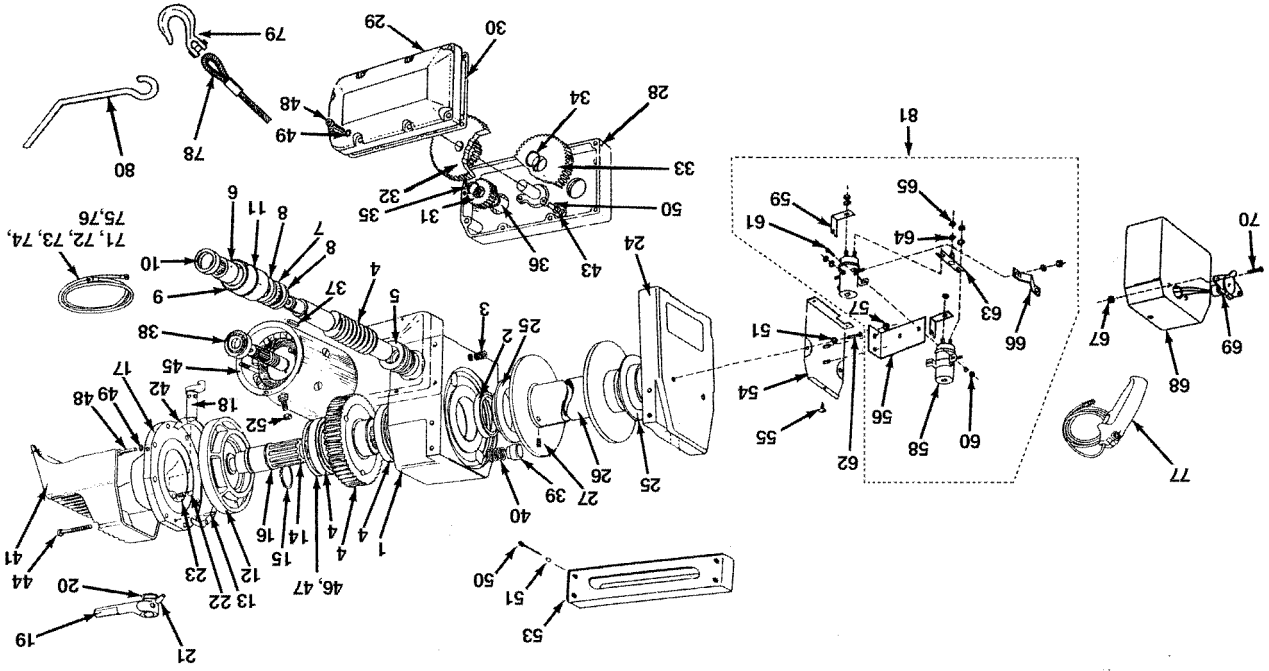

SUPERWINCH**LIMITED WARRANTY****VALID WORLDWIDE****LIMITED WARRANTY**

Superwinch Inc. ("Seller") warrants to the original buyer ("YOU") all parts and components except wire rope to be free of defects in materials and workmanship for a period of ONE (1) year from provable date of purchase. Any Superwinch product which is defective will be repaired or replaced without charge to you, upon compliance with these procedures. The warranties set forth herein are exclusive and in lieu of all other warranties, whether oral or written, express or implied.

LIMITED WARRANTY PERFORMANCE PROCEDURE

Upon discovery of a defective Superwinch product, you shall mail to the Seller at his factory or to any Factory Authorized Service Center written notice of such defect and mail, ship or otherwise deliver the defective Superwinch, postage or shipping prepaid. Repairs or replacements by Seller under this Limited Warranty will normally be accomplished within fifteen (15) business days after receipt of the defective Superwinch. Seller or its Authorized Agents may make reasonable charges for parts and labor for repairs not covered by this Limited Warranty.

WARRANTY AND REMEDY LIMITATIONS AND EXCLUSIONS

Repair and/or replacement of the defective Superwinch or component part thereof as provided herein is the exclusive remedy for you. The following exclusions or limitations of warranties and limitations of remedies shall be expressly applicable:

- A. Express Warranties. Seller Warrants that the Superwinch is as described in the "Superwinch Owner's Manual" provided herewith; no other express warranty is made in respect to the Superwinch. If any model or sample was shown to you, such model or sample was used for illustrative purposes only, and shall not be construed as a warranty that the Superwinch will conform to the sample or model. **SELLER MAKES NO EXPRESS WARRANTY WITH RESPECT TO THE WIRE ROPE INCORPORATED IN THE PRODUCT.**
- B. Implied Warranty. The implied warranty of merchantability and all other implied warranties shall only extend from the provable date of purchase for one (1) year. The wire rope is sold "as is," without any implied warranties. Some states within the U.S.A. do not allow limitations on how long an implied warranty lasts, so the above limitation may not apply to you.
- C. Incidental and Consequential Damages. **SUBJECT TO THE SELLER'S LIMITED WARRANTY OBLIGATIONS SET FORTH HEREIN, SELLER SHALL NOT BE RESPONSIBLE FOR INCIDENTAL DAMAGES OF ANY KIND, OR FOR CONSEQUENTIAL DAMAGES TO PROPERTY, LOSS OF PROFITS AND LOSS OF USE WHICH MAY BE CAUSED BY ANY DEFECT IN, OR MALFUNCTION, OR FAILURE OF THE ENCLOSED SUPERWINCH. SOME STATES WITHIN THE USA DO NOT ALLOW THE EXCLUSION OR LIMITATION OF INCIDENTAL OR CONSEQUENTIAL DAMAGES; SO THE ABOVE LIMITATION OR EXCLUSION MAY NOT APPLY TO YOU.**

D. Condition of Warranty. Seller shall not be required to comply with its warranty duties provided herein if the defect, malfunction, or failure of the Superwinch was caused by damage (not resulting from defective or malfunctioning components) or unreasonable use by you. Unreasonable use shall include, but not be limited to, the failure to provide reasonable and necessary maintenance or installation or use of the Superwinch without compliance with the instructions contained in the Superwinch Owner's Manual, and subjecting the Superwinch to loads in excess of the load listed in the Owner's Manual for the particular model number. Seller's liability under this warranty or for any loss or damage to the Superwinch product shall not exceed the cost of correcting the defects in or replacing the Superwinch product, and upon expiration of the warranty period, all such liability shall terminate. The agents, dealers and employees of the Seller are not authorized to make modifications to this warranty, or additional warranties binding on the Seller. Accordingly, additional statements, whether oral or written, do not constitute warranties and should not be relied upon.

LEGAL REMEDIES OF BUYER

This Limited Warranty gives you specific legal rights, and you may also have other rights which may vary from state to state within the USA and from country to country. You also have implied warranty rights. In the event of a problem with Limited Warranty service or performance, you may be able to go to small claims court, a state court, or federal district court in the USA or to appropriate jurisdictions outside the USA.

INQUIRIES

Any inquiries regarding compliance with warranties provided herein may be addressed in writing to: Superwinch Inc., Winch Drive, Putnam, CT 06260, USA or to: Superwinch Ltd., Abbey Rise, Whitchurch Road, Tavistock, Devon PL 19 9DR, England.

SUPERWINCH®**MANUAL DEL PROPIETARIO**

INSTALACIÓN • OPERACIÓN • MANTENIMIENTO
PRECAUCIONES DE SEGURIDAD
PIEZAS DE REPUESTO

HUSKY 10

Cabrestante eléctrico
de 12 y 24 Voltios CD
Nº de Pieza 2404 y 2405

▲ PRECAUCIÓN

**LEA Y ENTIENDA ESTE MANUAL ANTES DE
INSTALAR Y OPERAR SU PRODUCTO
SUPERWINCH.**

Superwinch, Inc.
Winch Drive
Putnam, CT 06260
E.U.A.

Superwinch, Ltd.
Abbey Rise, Whitchurch Road
Tavistock, Devon PL 19 9DR
Inglaterra

Tel. (860) 928-7787
Fax (860) 928-1143

Tel. + 44 (0) 1822 614101
Fax + 44 (0) 1822 615204

94-10035 Rev E 02/08/00